

# ***Nidec***

All for dreams

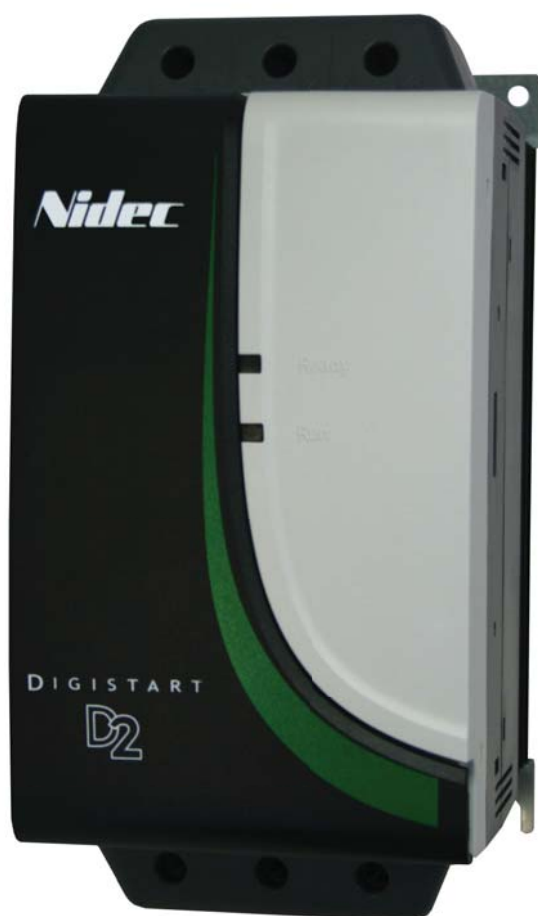

## *User Guide*

---

### ***Digistart D2***

***18 A - 200 A (7.5 - 110 kW)  
200V, 400V, 575V***

---

Part Number: 4258 en - 2017.12 / f

## **General Information**

The manufacturer accepts no liability for any consequences resulting from inappropriate, negligent or incorrect installation or adjustment of the optional parameters of the equipment or from mismatching the starter with the motor.

The contents of this guide are believed to be correct at the time of printing. In the interests of commitment to a policy of continuous development and improvement, the manufacturer reserves the right to change the specification of the product or its performance, or the content of the guide without notice.

All rights reserved. No parts of this guide may be reproduced or transmitted in any form or by any means, electrical or mechanical including, photocopying, recording or by an information storage or retrieval system, without permission in writing from the publisher.

## **Software Version**

This product is supplied with the latest version of user-interface and machine control software. If this product is to be used in a new or existing system with other starters, there may be some differences between their software and the software in this product. These differences may cause the product to function differently. This may also apply to starters returned from the Nidec Service Centre.

If there is any doubt, please contact Nidec or your local Distributor.

## **Environmental Statement**

Nidec is committed to minimising the impacts of its manufacturing operations. To this end, we operate an Environmental Management System (EMS) which is certified to the International Standard ISO 14001.

When the products eventually reach the end of their useful life, they can very easily be dismantled into their major component parts for efficient recycling. Many parts snap together and can be separated without the use of tools, while other parts are secured with conventional screws.

Product packaging is of good quality and can be re-used. Large products are packed in wooden crates, while smaller products come in strong cardboard cartons which themselves have a high recycled fibre content. If not re-used, these containers can be recycled. Polythene, used on the protective film and bags from wrapping product, can be recycled in the same way.

When preparing to recycle or dispose of any product or packaging, please observe local legislation and best practice.

## **REACH Legislation**

EC Regulation 1907/2006 on the Registration, Evaluation, Authorisation and restriction of Chemicals (REACH) requires the supplier of an article to inform the recipient if it contains more than a specified proportion of any substance which is considered by the European Chemicals Agency (ECHA) to be a Substance of Very High Concern (SVHC) and is therefore listed by them as a candidate for compulsory authorisation.

For current information on how this requirement applies in relation to specific Nidec products, please approach your usual contact in the first instance.

For the latest manuals and software, please visit our website.

---

# Contents

---

<b>1</b>	<b>Safety Information</b> .....	<b>4</b>
1.1	Electrical safety - general warning .....	4
1.2	System Design and Safety of Personnel.....	4
1.3	Environmental limits .....	4
1.4	Compliance with regulations .....	4
1.5	Motor .....	4
1.6	Adjusting parameters.....	4
1.7	Electrical Installation.....	5
<b>2</b>	<b>Rating Data</b> .....	<b>6</b>
2.1	Model Code .....	6
2.2	Current Ratings .....	6
<b>3</b>	<b>Mechanical Installation</b> .....	<b>7</b>
3.1	Dimensions and Weights.....	7
3.2	Physical Installation .....	8
<b>4</b>	<b>Electrical Installation</b> .....	<b>9</b>
4.1	Terminal layout.....	9
4.2	Schematic Diagrams .....	12
<b>5</b>	<b>Programmable Parameters</b> .....	<b>13</b>
5.1	Adjustments.....	13
<b>6</b>	<b>Diagnostics</b> .....	<b>16</b>
6.1	LEDs.....	16
6.2	Trip Codes .....	16
6.3	Reset .....	16
6.4	Protections.....	17
<b>7</b>	<b>Technical Data</b> .....	<b>18</b>
<b>8</b>	<b>Options</b> .....	<b>20</b>

# 1 Safety Information



## WARNING

Indicates a hazard that may cause personal injury or death.



## CAUTION

Indicates a hazard that may damage the equipment or installation.



## NOTE

Provides helpful information.

## 1.1 Electrical safety - general warning

The voltages used in the starter can cause severe electrical shock and/or burns, and could be lethal. Extreme care is necessary at all times when working with or adjacent to the starter.

Specific warnings are given at the relevant places in this guide.

## 1.2 System Design and Safety of Personnel

The starter is intended as a component for professional incorporation into complete equipment or a system. If installed incorrectly, the starter may present a safety hazard.

The starter uses high voltages and currents, carries stored electrical energy, and is used to control equipment which can cause injury.

Close attention is required to the electrical installation and the system design to avoid hazards either in normal operation or in the event of equipment malfunction. System design, installation, commissioning and maintenance must be carried out by personnel who have the necessary training and experience. They must read this safety information and this guide carefully.

**None of the starter functions must be used to ensure safety of personnel, ie they must not be used for safety-related functions.**

Careful consideration must be given to the functions of the starter which might result in a hazard, either through their intended behaviour or through incorrect operation due to a fault. In any application where a malfunction of the starter or its control system could lead to or allow damage, loss or injury, a risk analysis must be carried out, and where necessary, further measures taken to reduce the risk.

The system designer is responsible for ensuring that the complete system is safe and designed correctly according to the relevant safety standards.

## 1.3 Environmental limits

Instructions regarding transport, storage, installation and use of the starter must be complied with, including the specified environmental limits. Starters must not be subjected to excessive physical force.

## 1.4 Compliance with regulations

The installer is responsible for complying with all relevant regulations, such as national wiring regulations, accident prevention regulations and electromagnetic compatibility (EMC) regulations. Particular attention must be given to the cross-sectional areas of conductors, the selection of fuses or other protection, and protective ground connections.

Within the European Union, all machinery in which this product is used must comply with the following directives:

2006/42/EC: Safety of machinery.

2014/30/EU: Electromagnetic Compatibility.

## 1.5 Motor

Ensure the motor is installed in accordance with the manufacturer's recommendations. Ensure the motor shaft is not exposed.

## 1.6 Adjusting parameters

Some parameters have a profound effect on the operation of the starter. They must not be altered without careful consideration of the impact on the controlled system. Measures must be taken to prevent unwanted changes due to error or tampering.

## 1.7 Electrical Installation

### 1.7.1 Electrical shock risk

The voltages present in the following locations can cause severe electric shock and may be lethal:

- AC supply cables and connections
- Output cables and connections
- Many internal parts of the starter, and external option units

The AC supply must be disconnected from the starter using an approved isolation device before any cover is removed from the starter or before any servicing work is performed.

### 1.7.2 Power-up procedure



#### **WARNING**

Always apply control voltage before (or with) mains voltage.

After transportation, mechanical shock or rough handling there is a possibility that the bypass contactor may have latched into the on state. To prevent the possibility of the motor starting immediately, on first commissioning or operation after transportation, always ensure that the control supply is applied before the power, so that the contactor state is initialised.

### 1.7.3 STOP function

The STOP function does not remove dangerous voltages from the starter, the motor or any external option units.

### 1.7.4 Equipment supplied by plug and socket

The control supply terminals of the starter are connected to the internal capacitors through rectifier diodes which are not intended to give safety isolation. If the plug terminals can be touched when the plug is disconnected from the socket, a means of automatically isolating the plug from the starter must be used (e.g. a latching relay).

### 1.7.5 Short circuit

The Digistart D2 is not short circuit proof. After severe overload or short circuit, the operation of the Digistart D2 should be fully tested by an authorised service agent.

## 2 Rating Data

### 2.1 Model Code

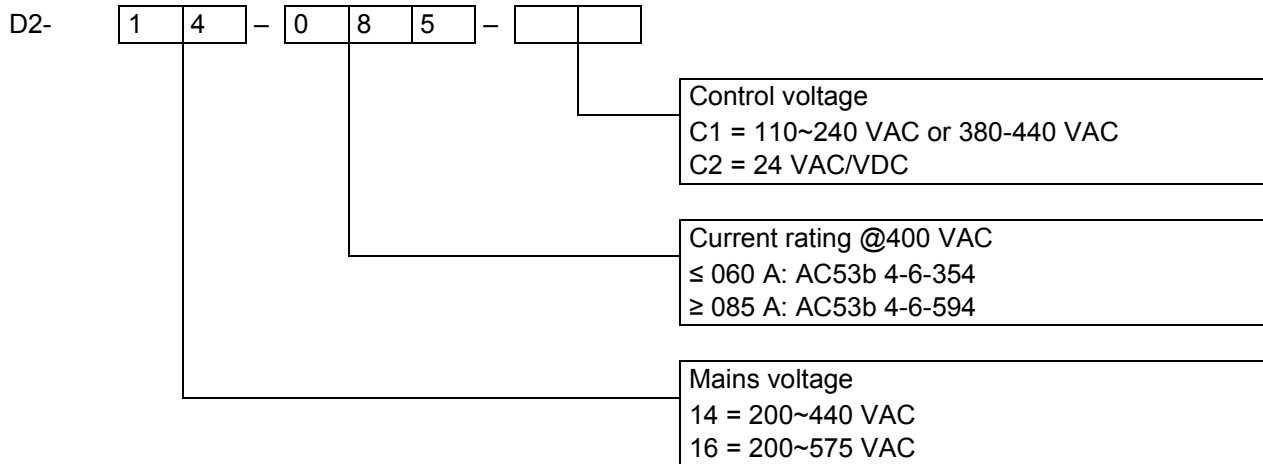

### 2.2 Current Ratings

Contact your local supplier for ratings under operating conditions not covered by these ratings charts.

	<b>AC53b 4-6:354 &lt; 1000 metres</b>		<b>AC53b 4-20:340 &lt; 1000 metres</b>	
	<b>40 °C</b>	<b>50 °C</b>	<b>40 °C</b>	<b>50 °C</b>
D2-018	18 A	17 A	17 A	15 A
D2-034	34 A	32 A	30 A	28 A
D2-042	42 A	40 A	36 A	33 A
D2-048	48 A	44 A	40 A	36 A
D2-060	60 A	55 A	49 A	45 A
	<b>AC53b 4-6:594 &lt; 1000 metres</b>		<b>AC53b 4-20 580 &lt; 1000 metres</b>	
	<b>40 °C</b>	<b>50 °C</b>	<b>40 °C</b>	<b>50 °C</b>
D2-075	75 A	68 A	65 A	59 A
D2-085	85 A	78 A	73 A	67 A
D2-100	100 A	100 A	96 A	87 A
D2-140	140 A	133 A	120 A	110 A
D2-170	170 A	157 A	142 A	130 A
D2-200	200 A	186 A	165 A	152 A

### 3 Mechanical Installation



**WARNING**

Models D2-140 to D2-200 are intended to be mounted in an enclosure which prevents access except by trained and authorised personnel, and which prevents the ingress of contamination. The complete range is designed for use in an environment classified as Pollution Degree 3 in accordance with IEC60664-1. This means conductive pollution or dry, non-conductive pollution which becomes conductive due to condensation is acceptable.

It is the installer's responsibility to ensure that any enclosure which allows access to models D2-140 to D2-200 while the product is energized, provides protection against contact and ingress requirements of IP20.

Models D2-140 to D2-200 can be installed with optional finger guards, in which case they do not need to be mounted in an enclosure.

#### 3.1 Dimensions and Weights

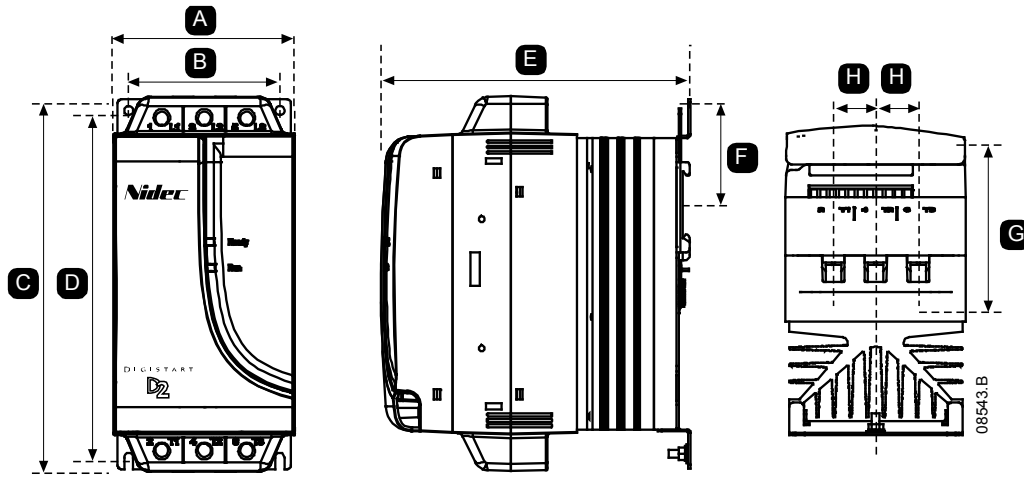

Model	Width mm (inch)		Height mm (inch)		Depth mm (inch)		mm (inch)	mm (inch)	Weight kg (lb)
	A	B	C	D	E	F	G	H	
D2-018									
D2-034	98	82	201	188	165	55	90.5	23	2.2
D2-042	(3.85)	(3.22)	(7.91)	(7.40)	(6.49)	(2.16)	(3.6)	(0.9)	(4.85)
D2-048									
D2-060									
D2-075									
D2-085	145	124	215	196	193	-	110.5	37	4.0
D2-100	(5.70)	(4.88)	(8.46)	(7.71)	(7.59)		(4.4)	(1.5)	(8.81)
D2-140									
D2-170	200	160	240	216	214	-	114.5	51	6.5
D2-200	(7.87)	(6.30)	(9.44)	(8.50)	(8.43)		(4.5)	(2.0)	(14.33)

### 3.2 Physical Installation

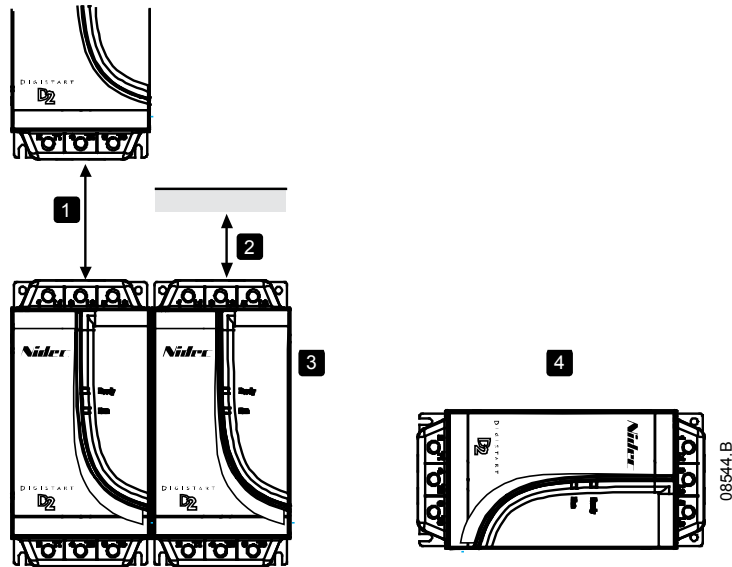

<b>1</b>	D2-018 ~ D2-100: Allow 100 mm (3.9 inch) between soft starters. D2-140 ~ D2-200: Allow 200 mm (7.9 inch) between soft starters.
<b>2</b>	D2-018 ~ D2-100: Allow 50 mm (2.0 inch) between the soft starter and solid surfaces. D2-140 ~ D2-200: Allow 200 mm (7.9 inch) between the soft starter and solid surfaces.
<b>3</b>	Soft starters may be mounted side by side with no clearance (that is, if mounted without communications modules).
<b>4</b>	The soft starter may be mounted on its side. Derate the soft starter's rated current by 15%.



## 4 Electrical Installation



### WARNING

Always apply control voltage before (or with) mains voltage.



### CAUTION

Always follow the specified tightening torque for all power and ground terminal connections.

All Digistart D2 starters include an internal bypass relay that bypasses the soft starter SCRs during run. This allows the Digistart D2 to be installed in a non-ventilated enclosure without an external bypass contactor.

### 4.1 Terminal layout

For specifications and detailed technical data, see *Technical Data* on page 18.

	1/L1, 3/L2, 5/L3, 2/T1, 4/T2, 6/T3 mm <sup>2</sup> (AWG)			CSL, CSR, CSH, DI1, DI2, TH1, TH2, COM2, RLO2, COM1, RLO1 mm <sup>2</sup> (AWG)
	018 - 060	075 - 100	140 - 200	018 - 200
	10 - 35 (8 - 2)  14 mm (0.55 inch)	25 - 50 (4 - 1/10)  14 mm (0.55 inch)	n/a  11 26 Ø 8.5 (1.02)(0.33) mm (inch)	0.14 - 1.5 (26 - 16)  6 mm (0.24 inch)
	Torx (T20) 3 Nm 2.2 ft-lb		Torx (T20) 4 Nm 2.9 ft-lb	n/a
	7 mm 3 Nm 2.2 ft-lb		7 mm 4 Nm 2.9 ft-lb	n/a  3.5 mm 0.5 Nm max 4.4 in-lb max

#### 4.1.1 Ground terminal

All Digistart D2 soft starters have one ground terminal at the bottom of the starter.

Model	Terminal size	Maximum Torque
D2-018 to D2-060	4 mm	2 Nm
D2-075 to D2-200	6 mm	3 Nm

### 4.1.2 Control Voltages

Digistart D2 soft starters can be supplied in either of two control voltage configurations:

D2-xxx-C1 .... 110-240 VAC (+ 10% / - 15%) or 380-440 VAC (+ 10% / - 15%)

D2-xxx-C2 .... 24 VAC/VDC ( $\pm 20\%$ )



#### CAUTION

Always connect control voltage to the correct terminals:

- 110~240 VAC: CSL, CSR
- 380-440 VAC: CSR, CSH
- 24 VAC/VDC: CSL, CSR



#### WARNING

The installer must ensure that the external control circuits are insulated from human contact by at least one layer of insulation (supplementary insulation) rated for use at the AC supply voltage.

Two-wire control

Three-wire control

110~240 VAC  
&  
24 VAC/VDC

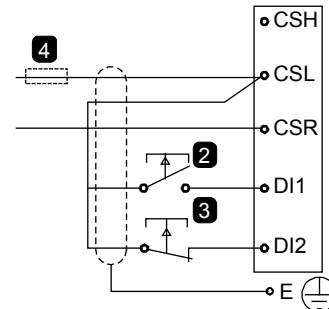
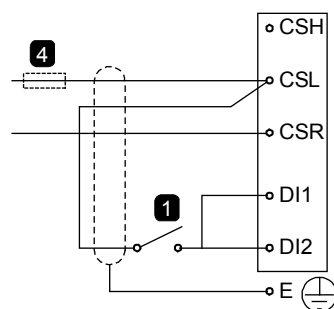

380-440 VAC

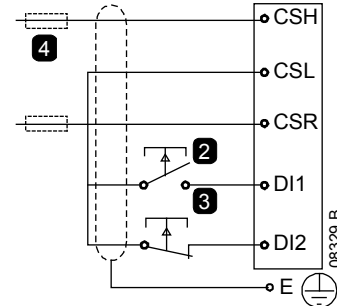
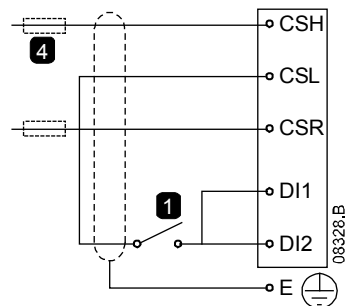

<b>1</b>	Start/Stop. To reset a trip, open then close DI2.	<b>3</b>	Stop. To reset a trip, open then close DI2.
<b>2</b>	Start.	<b>4</b>	Fuse (optional).

For sizing of the control fuse, see *Technical Data* on page 18.

The maximum cable run is determined by the type of cable used, provided the maximum resistance of this cable does not exceed 100 Ohms. The cables must be twisted in pairs and shielded. The shield must be grounded at one end only, that is, at the soft starter end. To avoid any EMC disturbance from the motor power cables, the thermistor cable must be separated from the motor power cables by a minimum parallel distance of 300 mm.

### 4.1.3 Motor Thermistor

Motor thermistors can be connected directly to the Digistart D2 terminals TH1, TH2. If motor thermistors are not used, there must be a link between TH1, TH2 (the Digistart D2 is supplied with a link fitted).

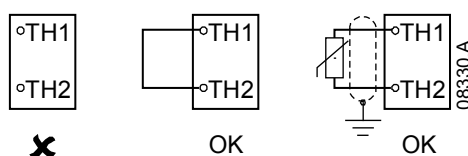

#### 4.1.4 Outputs

##### Main Contactor Output

The Main Contactor output (terminals COM2, RLO2) closes as soon as the soft starter receives a start command and remains closed while the soft starter is controlling the motor (until the motor starts a coast to stop, or until the end of a soft stop). The Main Contactor output will also open if the soft starter trips. The Main Contactor output can be used to directly control a main contactor coil.

##### Programmable Output

The programmable output relay (terminals COM1, RLO1) can be used to signal either trip or run status. This relay is normally open.

Trip:

The relay closes when the Digistart D2 trips. The relay can be used to operate the shunt-trip mechanism of an upstream circuit breaker (in order to isolate the motor branch circuit), or to signal the trip to an automation system or externally. The relay will open when the trip is reset.

Run:

The relay operates when the soft start is complete, the bypass relays are closed and full voltage is being applied to the motor. The relay can be used to operate a contactor for power factor correction capacitors, or to signal soft starter run status to an automation system.

#### 4.1.5 Semiconductor Fuses

Semiconductor fuses can be used with Digistart D2 soft starters to reduce the potential for damage to SCRs from transient overload currents and for Type 2 coordination. Digistart D2 soft starters have been tested to achieve Type 2 coordination with semiconductor fuses. Suitable Bussmann and Ferraz/Mersen semiconductor fuses are detailed below.

Model	SCR I <sup>2</sup> t (A <sup>2</sup> s)	Ferraz/Mersen Fuse European/IEC Style (North American Style)	Bussmann Fuse Square Body (170M)	Bussmann Fuse British Style (BS88)
D2-018	1150	6.6URD30xxxA0063 (A070URD30xxx0063)	170M-1314	63 FE
D2-034	8000	6.6URD30xxxA0125 (A070URD30xxx0125)	170M-1317	160 FEE
D2-042	10500	6.6URD30xxxA0160 (A070URD30xxx0160)	170M-1318	160 FEE
D2-048	15000	6.6URD30xxxA0160 (A070URD30xxx0160)	170M-1318	180 FM
D2-060	18000	6.6URD30xxxA0160 (A070URD30xxx0160)	170M-1319	180 FM
D2-075	51200	6.6URD30xxxA0250 (A070URD30xxx0250)	170M-1321	250 FM
D2-085	80000	6.6URD30xxxA0315 (A070URD30xxx0315)	170M-1321	250 FM
D2-100	97000	6.6URD30xxxA0315 (A070URD30xxx0315)	170M-1321	250 FM
D2-140	168000	6.6URD31xxxA0450 (A070URD31xxx0450)	170M-1322	500 FMM
D2-170	245000	6.6URD31xxxA0450 (A070URD31xxx0450)	170M-3022	500 FMM
D2-200	320000	6.6URD31xxxA0450 (A070URD31xxx0450)	170M-3022	500 FMM

xxx = Blade Type. Contact Ferraz/Mersen for options.

## 4.2 Schematic Diagrams

Soft starter installed with a system protection circuit breaker complete with a shunt trip device

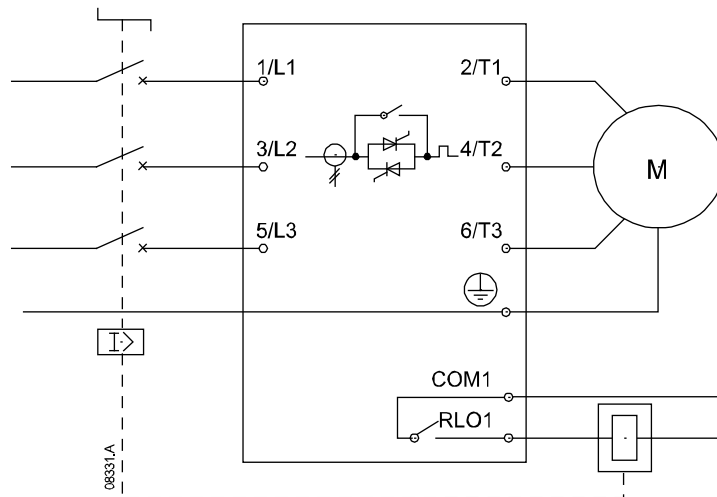

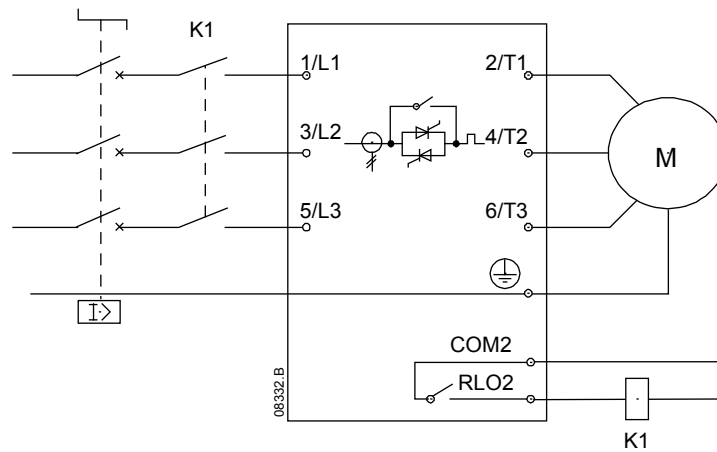

Soft starter installed with a system protection circuit breaker and main contactor



<b>M</b>	Motor (three phase)
<b>K1</b>	Main contactor
<b>COM2, RLO2</b>	Main contactor output
<b>COM1, RLO1</b>	Programmable output (set to Trip)

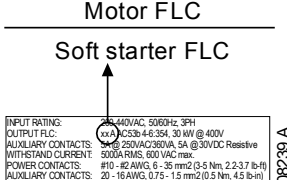
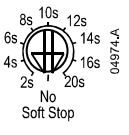
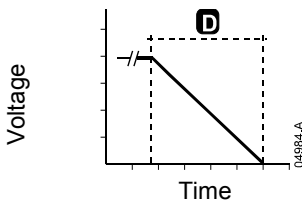

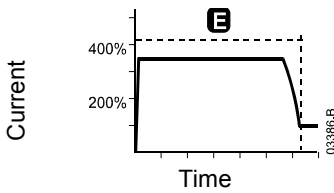
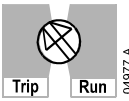
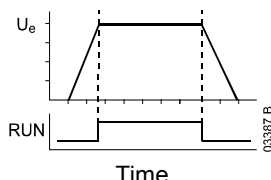
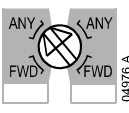
<p><b>4 Motor FLC</b></p>  <p>Configure the soft starter to match the motor's full load current (FLC). Configure according to the motor's nameplate current. Divide the motor's FLC by the soft starter's maximum current rating (on the soft starter's nameplate label).</p>										
<p><b>5 Soft Stop Time</b></p>  <p>Select the soft stop ramp time (D). Soft stop extends the time soft starter takes to reduce voltage to zero. The ramp time does not control the time the motor will take to stop completely.</p>										
<p><b>6 Excess Start Time</b></p>  <p>Configure the soft starter's excess start time protection. Select a time slightly longer than the motor requires for a normal healthy start. The soft starter will trip if the start does not complete within the selected time (E).</p>										
<p><b>7 Auxiliary Relay Function</b></p>  <p>Select the function of the soft starter's programmable output (terminals COM1, RLO1). When set to "Run", the relay will operate when the soft start is complete. When set to "Trip", the relay will operate when the soft starter trips.</p>										
<p><b>8 Phase Sequence Protection</b></p>  <p>Configure the soft starter's phase sequence protection. Select the allowable phase sequences. A setting of "Fwd" allows forward sequence (positive rotation) only and a setting of "Any" defeats the protection.</p>	<table border="1"> <thead> <tr> <th></th> <th>FWD</th> <th>ANY</th> </tr> </thead> <tbody> <tr> <td>L1 L2 L3 → soft starter →</td> <td>✓</td> <td>✓</td> </tr> <tr> <td>L1 L2 L3 → soft starter →</td> <td>✗</td> <td>✓</td> </tr> </tbody> </table> <p>reference number 04982.A</p>		FWD	ANY	L1 L2 L3 → soft starter →	✓	✓	L1 L2 L3 → soft starter →	✗	✓
	FWD	ANY								
L1 L2 L3 → soft starter →	✓	✓								
L1 L2 L3 → soft starter →	✗	✓								
<p><b>NOTE</b> Auxiliary relay function and phase sequence are configured using a shared switch. Set the auxiliary relay function as required, then set phase sequence protection.</p>										

• **Digistart D2 auxiliary relay and phase sequence protection examples**

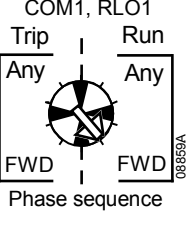
	<p>Relay action: After a start command, the relay will operate when the soft start is complete. The relay state will match the status of the Run LED. The relay will open if the starter trips. Phase sequence protection: The soft starter will allow forward sequence only (positive rotation). If the soft starter detects negative sequence, the starter will trip and the Ready LED will flash 7 times. Remove power, reverse the phase connections, then reset the starter.</p>
---	---

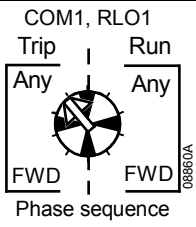

Relay action: The relay will close when a trip occurs. Reset the trip and resume operation.

Phase sequence protection: The soft starter will allow any phase sequence.

## 6 Diagnostics



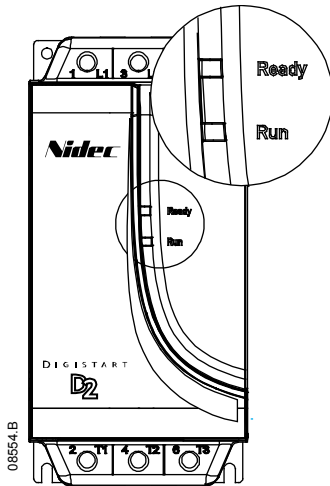







### 6.1 LEDs



LED Status	Ready	Run
Off	No control power	Motor not running
On	Ready	Motor running at full speed
Flash	Starter tripped	Motor starting or stopping

### 6.2 Trip Codes

The Ready LED will flash a different number of times to indicate the cause of the trip.

Ready LED	Description
 x 1	Power Circuit: Check mains supply (L1, L2, L3), motor circuit (T1, T2, T3), soft starter SCRs and bypass relays.
 x 2	Excess Start Time: Check load, increase Current Limit or adjust Excess Start Time setting.
 x 3	Motor Overload: Allow motor to cool, reset soft starter and restart. The soft starter cannot be reset until the motor has cooled.
 x 4	Motor Thermistor: Check motor ventilation and thermistor connection TH1, TH2. Allow motor to cool.
 x 5	Current imbalance: Check for mains supply or line current imbalance (L1, L2, L3).
 x 6	Supply Frequency: Check mains voltage is available and supply frequency is in range.
 x 7	Phase sequence: Check for correct phase sequence.
 x 8	Network Communication Failure (between module and network): Check network connections, settings and configuration.
 x 9	Starter Communication Failure (between starter and module): Remove and refit accessory module.
 x 10	Bypass Overload: Starter rating may be too low for the application.

### 6.3 Reset

Trips can be cleared by pressing the Reset button on the soft starter, sending a Reset command from the serial communications network, or by switching the control inputs.

To clear a trip via the control inputs, the soft starter requires a closed to open transition on the stop input (DI2).

- In three-wire control, use the external stop button to momentarily open the stop input (open CSL-DI2).
- In two-wire control, if the soft starter tripped with a start signal present, remove the start signal (open CSL to DI1, DI2).
- In two wire control, if the Digistart D2 tripped with no start signal present (eg Digistart D2 motor thermistor trip), apply then remove the start signal (close then reopen CSL to DI1, DI2).

The Reset button is located on the front of the unit, above the adjustment switches.

The soft starter will trip again immediately if the cause of the trip still exists.



## 6.4 Protections

The Digistart D2 includes the following types of protection for the motor and starter:

### 6.4.1 Excess Start Time Protection

The Digistart D2 will trip on excess start time if the motor does not successfully start within the time selected in the Excess Start Time setting. This may indicate that the load has stalled.

If the soft starter frequently trips on excess start time:

- check that the Current Limit setting is high enough for the application
- check that the Excess Start Time setting is long enough for the application
- check that the load has not stalled or increased since the soft starter was installed

### 6.4.2 Motor Overload Protection

The Digistart D2 will trip on motor overload if it calculates that the motor has been running above its operating range for longer than the time selected in the Motor Trip Class setting. Motor Trip Class should be set to match the motor's locked rotor time. If this information is not available from the motor datasheet, use the default setting (Motor Trip Class = 10). Using a higher setting can damage the motor.



#### NOTE

Motor overload protection does not protect the soft starter, and does not protect the motor from short circuit.

### 6.4.3 Current Imbalance Protection

The Digistart D2 will trip on current imbalance if the highest and lowest currents on the three phases vary by an average of 30% for more than 3 seconds. Current imbalance protection is not adjustable, and is only active when the average motor current is 50% or more of the programmed motor FLC.

If the soft starter frequently trips on current imbalance:

- check that there is no imbalance on the mains voltage (on the input side of the soft starter)
- insulation test the motor
- move all input cables over one position (move L1 cable to L2, move L2 cable to L3, move L3 cable to L1) to rule out a cabling fault

### 6.4.4 Supply Frequency Protection

The soft starter will trip on supply frequency if the frequency rises above 72 Hz or falls below 40 Hz for more than five seconds while the soft starter is running. These trip points are not adjustable.

In pre-start, starting and stopping modes the high and low frequency limits both apply with no time delay.

A supply frequency trip will also occur if:

- all three input phases are lost while the soft starter is running
- all three input phases fall below 120 VAC at start or while the soft starter is running
- the line contactor opens while running

### 6.4.5 Bypass Overload Protection

Bypass overload protection protects the soft starter from severe operating overloads while running. The protection is not adjustable and has two components:

- The soft starter will trip if it detects overcurrent at 600% of the programmed motor full load current.
- The soft starter models the temperature of the internal bypass relays and will trip if the temperature exceeds the safe operating level.

If the trip occurs frequently, this indicates that the soft starter has not been selected correctly for the application.

---

## 7 Technical Data

---

### • Mains Supply

Mains voltage (L1, L2, L3)

D2-14-xxx ..... 3 x 200 VAC ~ 440 VAC (+ 10% / - 15%)

D2-16-xxx ..... 3 x 200 VAC ~ 575 VAC (+ 10% / - 15%)

Mains frequency (at start) ..... 45 Hz to 66 Hz

Rated insulation voltage ..... 600 VAC

Form designation ..... Bypassed semiconductor motor starter form 1

### • Control voltage (CSH, CSL, CSR)

D2-1x-xxx-C1 ..... 110-240 VAC (+ 10% / - 15%)  
or 380-440 VAC (+ 10% / - 15%)

D2-1x-xxx-C2 ..... 24 VAC /VDC (+ 10% / - 15%)

Recommended fuse ..... 1 A continuous (10 A max, 0.01 second surge)

Current consumption (during run) ..... < 100 mA

Current consumption (inrush) ..... 10 A

### • Inputs

Start (terminal DI1) ..... Normally open, 150 kΩ @ 300 VAC

Stop (terminal DI2) ..... Normally closed, 150 kΩ @ 300 VAC

Motor thermistor ..... Trip > 3.6 kΩ

### • Outputs

Main contactor relay (terminals COM2, RLO2) ..... Normally open  
6 A, 30 VDC / 6 A, 250 VAC resistive

Programmable relay (terminals COM1, RLO1) ..... Normally open  
6 A, 30 VDC / 6 A, 250 VAC resistive

### • Environmental

Degree of Protection D2-018 to D2-100 ..... IP20

Degree of Protection D2-140 to D2-200 ..... IP00

Operating temperature ..... - 10 °C to + 60 °C

Storage temperature ..... -25 °C~+ 60 °C (to +70 °C for less than 24 hours)

Humidity ..... 5%~95% Relative Humidity

Pollution degree ..... Pollution Degree 3

Vibration ..... IEC 60068 Test Fc Sinusoidal  
4 Hz to 13.2 Hz: ± 1 mm displacement  
13.2 Hz to 200 Hz: ± 0.7 g

### • EMC Emission

Equipment class (EMC) ..... Class B

Conducted radio frequency emission ..... 0.15 MHz to 0.5 MHz: < 56-46 dB (µV)  
0.5 MHz to 5 MHz: < 46 dB (µV)  
5 MHz to 30 MHz: < 50 dB (µV)

Radiated radio frequency emission ..... 30 MHz to 230 MHz: < 30 dB (µV/m)  
230 MHz to 1000 MHz: < 37 dB (µV/m)

### • EMC Immunity

Electrostatic discharge ..... 4 kV contact discharge, 8 kV air discharge

Radio frequency electromagnetic field ..... 0.15 MHz to 1000 MHz: 140 dB (µV)

Rated impulse withstand voltage (Fast transients 5/50 ns) ..... 2 kV line to ground, 1 kV line to line

Voltage dip and short time interruption ..... 100 ms (at 40% nominal voltage)

Harmonics and distortion ..... IEC61000-2-4 (Class 3), EN/IEC61800-3

### • Short Circuit

Rated short-circuit current D2-018 to D2-048 ..... 5 kA <sup>1</sup>

Rated short-circuit current D2-060 to D2-200 ..... 10 kA <sup>1</sup>

<sup>1</sup> These short circuit ratings are with fuses used as given in the table under *Semiconductor Fuses* on page 11.

- **Heat Dissipation**

During Start ..... 3 watts / ampere  
During Run ..... 10 watts typical

- **Approvals**

UL / C-UL ..... UL 508  
CE ..... EN 60947-4-2  
RoHS ..... Compliant with EU Directive 2011/65/EU

## 8 Options

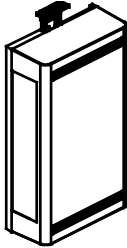
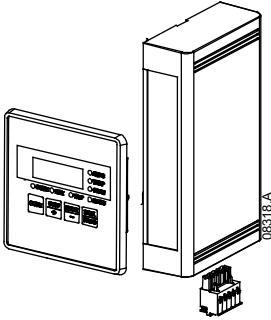
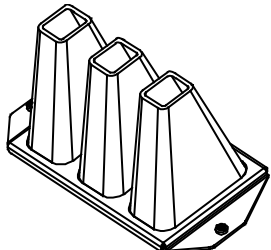
Option name	Function
Digistart - DeviceNet Interface	<p>Fieldbus communications modules.</p> <p> <b>NOTE</b> Ethernet communication modules are not suitable for use with Digistart D2 starters using 380/440 VAC control voltage.</p>  08317.B
Digistart - Ethernet IP Interface	
Digistart - Modbus Interface	
Digistart - Modbus TCP Interface	
Digistart - Profibus Interface	
Digistart - Profinet Interface	
Digistart - USB Interface	
Digistart-Soft	<p>The PC software is a fully functional program for controlling, monitoring and programming soft starters. It provides the following functionality:</p> <p>Operation of soft starter networks containing up to 254 individual soft starters</p> <ul style="list-style-type: none"> <li>Operational control (Start, Stop, Reset, Quick Stop)</li> <li>Starter status monitoring (Ready, Starting, Running, Stopping, Tripped)</li> <li>Performance monitoring (motor current, motor temperature)</li> </ul> <p>To use Digistart-Soft with the Digistart D2, the soft starter must be fitted with a USB Module, Modbus Module or a Remote Operator.</p>
Digistart D2 - Remote Keypad	<p>The Remote Keypad and Interface Kit comprises a Remote Keypad Interface module and the Remote Keypad display and keypad.</p> <p>The Remote Keypad can control and monitor the soft starter's performance. Functionality includes:</p> <ul style="list-style-type: none"> <li>Operational control (Start, Stop, Reset, Quick Stop)</li> <li>Starter status monitoring (Ready, Starting, Running, Stopping, Tripped)</li> <li>Performance monitoring (motor current, motor temperature)</li> <li>Trip code display</li> <li>4-20 mA analog output (motor current)</li> </ul>  08318.A
Digistart D2 - Finger Guard Kit	<p>Finger guards may be specified for personnel safety. Finger guards fit over the soft starter terminals to prevent accidental contact with live terminals. Finger guards provide IP20 protection when used with cable of diameter 22 mm or greater.</p>  08318.A





7 1 0 - 0 8 0 1 4 - 0 0 F